

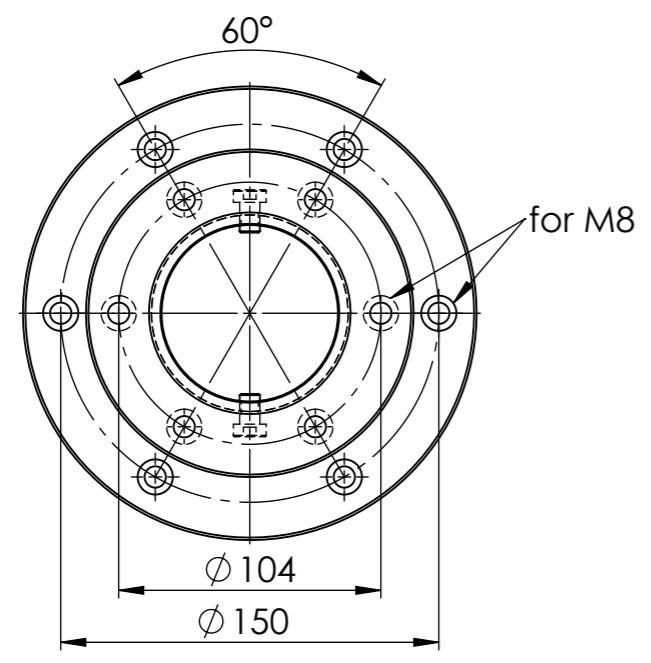

1 2 3 4 5 6 7 8

A
B
C
D
E
F

A
B
C
D
E
F

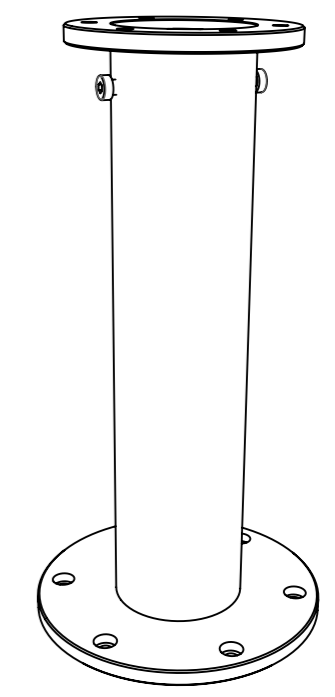
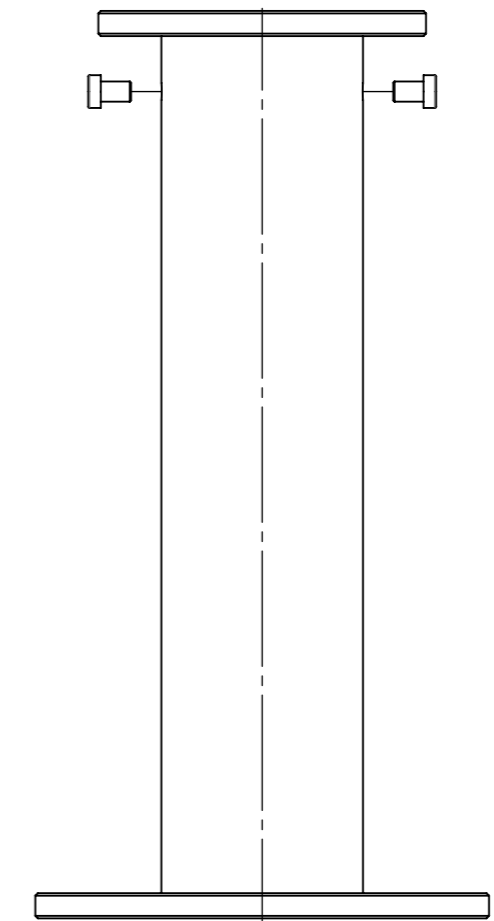
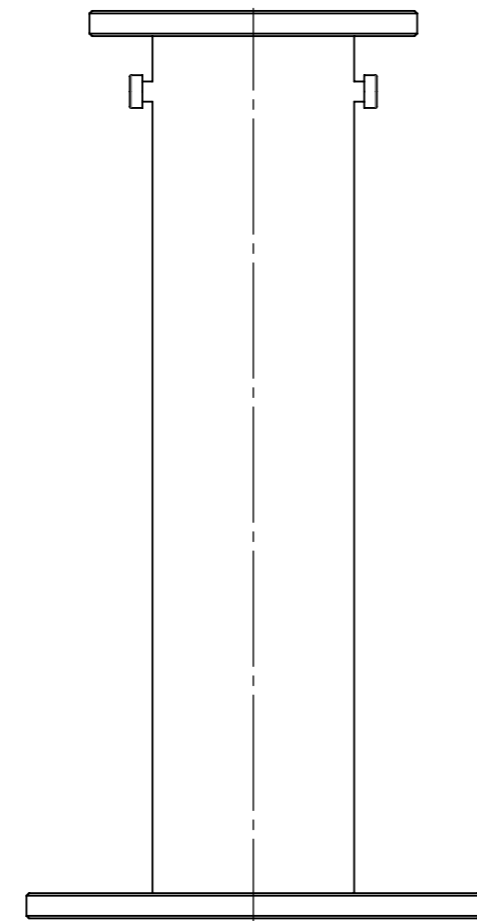
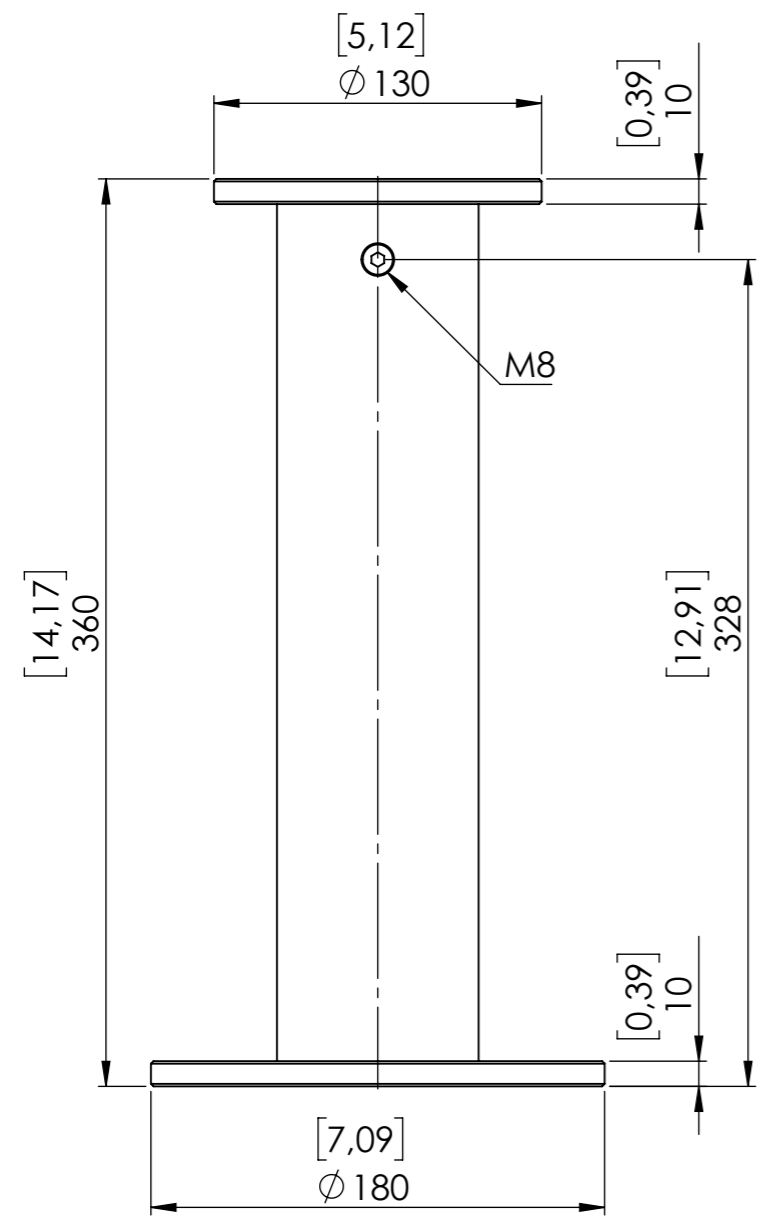

Unless otherwise specified: Dimensions are in millimeters. Tolerances according to DIN/ISO 2768-mK. Debur and break sharp edges. Material to comply with EU RoHS Directive 2002/95/EC.	Rev.By:	Rev.Date:	Sheet 1 of 1
	Material:		
 Lyngdorf Audio, Denmark www.lyngdorf.com	Finish:		Creator: Brian Nielsen
	Colour:	Weight:	Description: Stand for Steinway Marine Speaker
	Part No.: (Revision)		

Proprietary and confidential.
 The information contained
 in this drawing is the sole
 property of Lyngdorf Audio.
 Any reproduction in part or
 as a whole without the written
 permission of Lyngdorf Audio
 is prohibited.

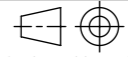

Scale: Not to scale